

Article number: 12857000020820
Description: KLEE-coil 857 000 020.820
M2 Brass

Measures

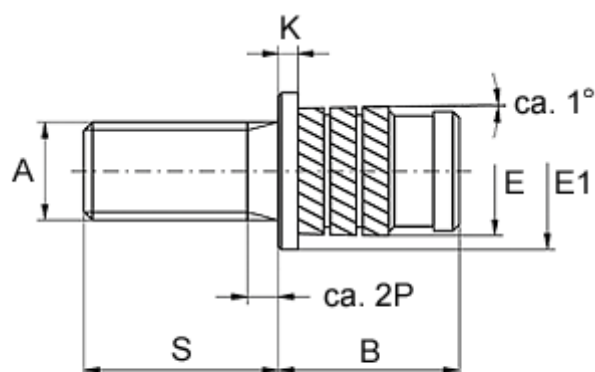

Gevindlængde = $S - 2P$
P = stigning

Flange diameter E1	= 4.8
Flange height	= 0.6
Male thread A	= M2x0,4
Min distance to edge	= 1.6
Mounting length B	= 4.0
Outer diameter E	= 3.35
Pin length S	= 6
Recommended bore diameter	= 3.1